

# metos

COFFEE MAKER

PERCOSTAR 6, 12, 15

---

## Installation and Operation Manual





---



---

MG4157252, MG4157254

---

Nederlands.....	1	
English .....	9	
Deutsch.....	15	
Français .....	21	

Dit apparaat voldoet aan de volgende EEG-richtlijnen:  
 This appliance is in accordance with the following Directives:  
 Dieses Gerät wurde in Übereinstimmung gemäß den folgenden Richtlinien gebaut:  
 Cet appareil est conforme aux directives:



EMC 92/31/EEG &  
93/68/EEG  
LVD 73/23/EEG



RoHS 2002/95/EEG  
WEEE 2002/96/EEG



FOOD 1935/2004/EEG

De fabrikant behoudt zich het recht voor om onderdelen op elk gewenst moment te wijzigen, zonder voorafgaande of directe kennisgeving aan de afnemer. De inhoud van deze handleiding kan eveneens gewijzigd worden zonder voorafgaande waarschuwing. Deze handleiding is geldig voor de machine in standaarduitvoering. De fabrikant kan derhalve niet aansprakelijk worden gesteld voor eventuele schade voortvloeiende uit van de standaard uitvoering afwijkende specificaties van de aan u geleverde machine. Voor informatie betreffende afstelling, onderhoudswerkzaamheden of reparaties waarin deze handleiding niet voorziet, wordt u verzocht contact op te nemen met de technische dienst van uw leverancier. Deze handleiding is met alle mogelijke zorg samengesteld, maar de fabrikant kan geen verantwoording op zich nemen voor eventuele fouten in dit boek of de gevolgen daarvan.

The manufacturer has the right to change parts of the machine at any time without advice or direct announcements to the client. The contents of this manual can also be changed without any announcements. This manual is to be used for the standard model/type of the machine. Thus The manufacturer cannot be held responsible for any damage resulting from the application of this manual to the version delivered to you. For extra information on adjustments maintenance and repair, contact the technical department of your supplier. This manual has been written very carefully. However, the manufacturer cannot be held responsible neither for mistakes in the book nor for their consequences.

Der Produzent behält sich das Recht vor, Einzelteile ohne vorherige Bekanntgabe an den Kunden zu ändern. Der Inhalt dieser Anleitung kann ebenfalls ohne vorherige Bekanntgabe geändert werden. Diese Anleitung gilt für die Standardausführung der Maschine. Der Produzent haftet daher nicht für Informationen über Einstellungen, Wartungsarbeiten oder Reparaturen, die nicht in dieser Anleitung enthalten sind. Wenden Sie sich bitte gegebenenfalls an den Kundendienst Ihres Händlers. Diese Anleitung wurde mit größtmöglicher Sorgfalt zusammengestellt. Der Produzent haftet jedoch nicht für etwaige Fehler in dieser Anleitung oder für die Folgen solcher Fehler.

Le fabricant se réserve le droit de modifier les pièces à n'importe quel instant, sans avis préalable et sans obligation de notification au client. Le contenu de ce manuel est également sujet à modification sans avis préalable. Ce manuel s'applique au modèle standard de la machine. Par conséquent, Le fabricant n'est pas responsable pour les dommages éventuels découlant de l'application de ce manuel aux modèles non standard. Pour les renseignements sur certains réglages, les travaux d'entretien ou réparations qui ne seraient pas traités dans ce manuel, le fabricant ne peut être tenu responsable des erreurs éventuelles ni des dommages qui en découleraient.

**TABLE OF CONTENTS**

1.	GENERAL DESCRIPTION .....	10
2.	TECHNICAL DETAILS .....	10
3.	INSTALLATION .....	11
3.1	Placing the coffeemaker .....	11
3.2	Connection to the electricity supply system .....	11
4.	CONTROLS .....	12
5.	PREPARATION BEFORE USE .....	12
6.	OPERATION .....	12
6.1	Making coffee (Brewing coffee) .....	12
6.2	Hot water for instant products .....	12
7.	MAINTENANCE .....	13
7.1	Normal cleaning after use .....	13
7.2	Special cleaning every two weeks .....	13
7.3	Descaling .....	13
8.	TEMPERATURE PROTECTION .....	14
9.	TRANSPORT .....	14

This manual has been written for users of the Percostar coffeemaker.  
Please, read this manual carefully for good and safe use of this appliance.

## 1. GENERAL DESCRIPTION

The Percostar 6.5 L, 12 L and 15 L are semi-automatic coffeemakers, manual filled with the required quantity of cold water. The coffeemaker is made of stainless steel and beautifully designed and finished. Both coffeemakers function according to the percolator principle and therefore are able to produce great quantities of high quality coffee, in comparing to other low priced coffeemakers. The coffeemakers are supplied with a beautifully designed tap with sight glass.

In figure 1 the main parts are indicated:

- |                           |                      |
|---------------------------|----------------------|
| A - Lid                   | H - Sight glass      |
| B - Lid for filter basket | I - Tap              |
| C - Percolator pipe       | J - On/Off switch    |
| D - Basket                | K - Indication light |
| E - Handle                | L - Cable with plug  |
| F - Grate                 |                      |
| G - Reservoir             |                      |

The coffeemaker is supplied with the following parts:  
- Manual perco

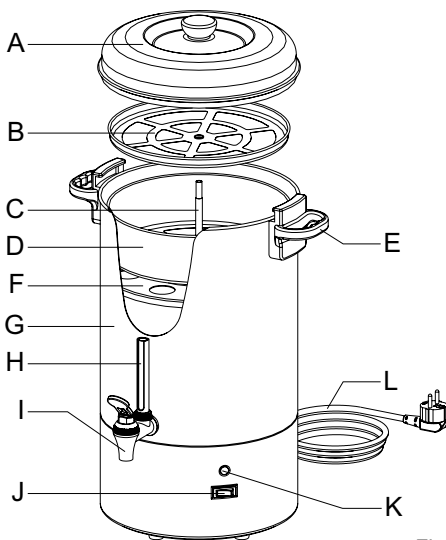

Fig. 1

## 2. TECHNICAL DETAILS

Type	: Percostar 6.5 L	Percostar 12 L	Percostar 15 L
Articlenumber	: 10407	10412	10417
Contents	: 6,5 ltr., 50 cups	12 ltr., 96 cups	15 ltr., 120 cups
Min. brewing quantity	: 3,2 ltr., 25 cups	6 ltr., 48 cups	7,5 ltr., 60 cups
Hour capacity	: ca. 10 ltr., 80 cups	ca. 15 ltr., 120 cups	ca. 15 ltr., 120 cups
Brewing time max. quantity	: ca. 40 min.	ca. 50 min.	ca. 65 min.
Connection	: 1N~ 230V/50-60 Cy	1N~ 230V/50-60 Cy	1N~ 230V/50-60 Cy
Power	: 1500 W	1500 W	1500 W
Length of electric cable	: 1,5 mtr.	1,5 mtr.	1,5 mtr.
Dimension Ø x H	: 230 x 480 mm	275 x 540 mm	275 x 600 mm
Outlet height tap	: 115 mm	140 mm	140 mm
Weight	: 3,5 kg	4,9 kg	5,2 kg

*Technical alterations are reserved*

## WARNING

- \* Always observe local rules while installing the unit and use approved materials and parts.
- \* Do not position the coffeemaker in areas where the temperature drops below freezing point because there is always water left in the system.
- \* Always plug the coffeemaker into an earthed wall socket.
- \* The outside of the coffeemaker gets very hot during use. Do not touch!
- \* Do not submerge or spray the coffeemaker.
- \* Do not switch on the coffeemaker if there is no water in the reservoir
- \* Always remove the plug from the socket if the coffeemaker has to be opened for repair or maintenance.
- \* Have all repairs carried out by a specially trained technician.
- \* If the coffeemaker is not used it is advisable to remove the plug from the socket and turn off the water tap.

### 3. INSTALLATION

Follow the instructions to place and connect the coffeemaker, specified below.

#### 3.1 Placing the coffeemaker

Place the unit:

- at counter level and on a solid flat surface.
- where it can be connected to the electricity grid.
- Such that it is not causing any damage in case of leakage.

#### 3.2 Connection to the electricity supply system

Depending on the model, the coffeemaker should be connected according to the instructions in the figures below.

- (fig. 2) For 230V 1 phase with plug socket.
- (fig. 2) For 230V 1 phase (3-core cable).

The following remarks apply to figure 2:

- If the plug fitted on the coffeemaker cable does not fit in your socket, replace it with a new plug that does fit.
- The replaced plug should be disposed of as it can be dangerous if plugged in a socket.

The following points should be observed when wiring a new plug:

- The green/yellow-coloured wire ("EARTH") should be connected to the terminal which is either marked with the letter "E", the "earth" symbol ( $\perp$ ), or coloured green or green/yellow.
- The blue-coloured wire ("NEUTRAL") should be connected to the terminal which is either marked with the letter "N" or coloured black.
- The brown-coloured wire ("PHASE") should be connected to the terminal which is either marked with the letter "L" or coloured brown.

#### IMPORTANT !

The three core main cable (fig. 2) has the following wiring code:

Green/Yellow	-	Earth
Blue	-	Neutral
Brown	-	Phase

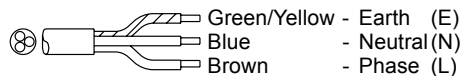

Fig. 2

## 4. CONTROLS

On/Off switch (fig. 1J)

Indication light (fig. 1K)

## 5. PREPARATIONS BEFORE USE

The following procedure should be carried out before a new coffeemaker is used.

1. Clean before use the basket, lid for filter basket, percolator pipe and the inside of the reservoir with a non-abrasive detergent.
2. Place the percolator pipe through the center of the grate and place it in the reservoir.
3. After you have followed the instructions above, place the plug in the socket with earth, but be sure that the coffeemaker is switched off.
4. The machine is now ready for use.

## 6. OPERATION

Basic rules for making coffee

- Use preferably regular grinded coffee. (approx. 40 gram/Litre or 6 gram/cup)
- Never make lesser coffee then half of the total capacity (in case of the perco 6,5 this means 3,2 Litres).
- Keep the filter and the reservoir clean.

### 6.1 Making coffee (Brewing coffee)

1. Insert the percolator pipe (fig. 3A) through the center of the grate (fig. 3B) and place it in the reservoir. Make sure that the foot of the percolator pipe is positioned firmly on the cavity of the base.
2. Fill the reservoir with cold water in accordance with the amount of coffee required.
3. Place the regular grinded coffee in the filter (fig. 3C).
4. Close the filter with the filter basket lid (fig. 3D).
5. Place the closed filter over the percolator pipe in the reservoir.

6. Put the top lid on the coffeemaker. Do not remove the lid during coffee making!
7. Switch the coffeemaker on ( fig. 1J ).
8. When the red pilot ( fig. 1K ) goes on , the coffee is ready and will be kept warm automatically.
9. When about three cups remain in the reservoir and coffee can no longer be seen in the sight glass, switch the coffeemaker off and remove the plug from the socket.
10. Remove the filter from the reservoir and empty this one by tapping the remaining coffee into a waste bin.
11. Rinse the filter basket, the lid and the percolator pipe under the tap.
12. After cleaning the reservoir, the coffeemaker is ready to be used again.

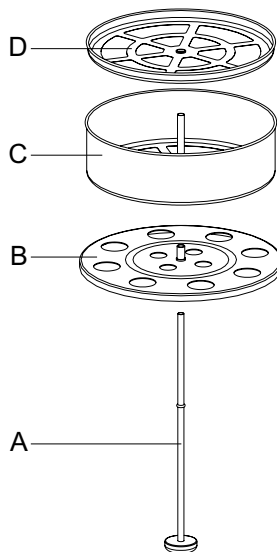

Fig. 3

### 6.2 Hot water for instant products

This coffeemaker can also be used for heating up water for use with instant products. Proceed with section 6.1 making coffee, without filling the filter.

In case the coffeemaker is used to heat up water only, be sure that the reservoir is cleaned thoroughly. For periodic cleaning see chapter 7. Maintenance.

## **WARNING**

- Stay near the machine while maintenance is being carried out.
- When descaling, always follow the instructions of the descaling agent used.
- It is advisable to wear protecting glasses and gloves during descaling.
- Allow the machine to run through at least three times to rinse the solution from the system after it has been descaled.
- Wash your hands thoroughly after descaling
- The appliance should not be submerged or hosed off.
- Make sure all the repairs to the appliance are carried out by a qualified technician.

## **7. MAINTENANCE**

### **7.1 Normal cleaning after use**

- Clean the filter basket, filter basket lid and the top lid with a non-abrasive detergent and then dry them off with a soft dry cloth.
- The outside of the coffeemaker can be cleaned with a soft damp cloth and then dried off with a soft dry cloth. Do not use any abrasives as these can cause scratches and mat spots.
- The inside of the reservoir and the percolator pipe can be cleaned with a coffee fur remover.
- For cleaning of the tap, remove the upper assembly from the tap and clean the tap with the brush through the tapconnection at the innerside of the coffeemaker. For the upper assembly, make a solution of coffee fur remover and let the part soak for 15 - 30 minutes.

### **7.2 Special cleaning every two weeks**

If the cavity is not be kept free from fur, the coffeemaker will not percolate well, resulting in weak and luke warm coffee. For a proper use the following instructions has to be carried out.

1. If the coffeemaker is used daily, the cavity must be cleaned every two weeks with a coffee fur remover. For this, switched the coffeemaker off and remove the plug from the socket.
2. Allow the reservoir to drain until no more water comes out of the tap and let the percolator cool off.
3. After cleaning, the cavity has to be rinsed several times with warm water, and drained off.

### **7.3 Descaling**

During use - depending on the hardness of the water -, the cavity of the coffeemaker can be furred up. For energy saving and fault free functioning, the coffeemaker has to be cleaned regulary with a scale remover.

1. Make a solution of a scale remover ( see instructions on the packaging ).
2. Insert the percolator pipe through the center of the grate and place it in the reservoir. Make sure that the foot of the percolator pipe is positioned firmly on the cavity of the base.
3. Pour 1 Litre of the scale solution in the reservoir, place the top lid on the reservoir and switch the coffeemaker on. The solution will now flush throught the system.
4. Leave the coffeemaker switched on for 15 minutes.
5. Switch the coffeemaker off and tap off the acid solution completely.
6. Rinse the inside of the reservoir and the parts thoroughly with hot water.
7. The coffeemaker is now ready to use.

---

## 8. TEMPERATURE PROTECTION

### **WARNING**

- Also clean the percolator pipe regularly in order to prevent the dry boil protection from becoming operative (see chapter 7 "MAINTENANCE").

This coffeemaker is executed with a temperature protection. This protection switches the coffeemaker off when temperature rise too high, the indication light in the switch will switch off. The most common cause for switching off is when the percolator is switched on without water inside or scale that has not been removed in time.

If the protection operates proceed as follows:

1. Remove the plug from the socket.
2. Drain the reservoir completely and let the coffeemaker cool down.

When the protection was triggered due to scale formation, then proceed according to section 7.3. When the cause was not in scale formation, then contact your dealer.

## 9. TRANSPORT

Proceed as follows to transport the coffee-maker:

1. Switch the coffeemaker off and remove the plug from the wall socket.
2. Remove the lid from the reservoir.
3. Turn the coffeemaker upside down to let the remaining water out over the sink.
4. Replace the lid
5. The coffeemaker is now ready for transportation.
6. Proceed with section 3 "INSTALLATION" to reinstall the unit.